

Classical versus Transparent IP Proxies

Status of this Memo

This memo provides information for the Internet community. This memo does not specify an Internet standard of any kind. Distribution of this memo is unlimited.

Abstract

Many modern IP security systems (also called "firewalls" in the trade) make use of proxy technology to achieve access control. This document explains "classical" and "transparent" proxy techniques and attempts to provide rules to help determine when each proxy system may be used without causing problems.

Table of Contents

1. Background	2
2. Direct communication (without a proxy)	3
2.1. Direct connection example	3
2.2. Requirements of direct communication	5
3. Classical application proxies	5
3.1. Classical proxy session example	6
3.2. Characteristics of classical proxy configurations	12
3.2.1. IP addressing and routing requirements	12
3.2.2. IP address hiding	14
3.2.3. DNS requirements	14
3.2.4. Software requirements	15
3.2.5. Impact of a classical proxy on packet filtering	15
3.2.6. Interconnection of conflicting IP networks	16
4. Transparent application proxies	19
4.1. Transparent proxy connection example	20
4.2. Characteristics of transparent proxy configurations	26
4.2.1. IP addressing and routing requirements	26
4.2.2. IP address hiding	28
4.2.3. DNS requirements	28
4.2.4. Software requirements	29
4.2.5. Impact of a transparent proxy on packet filtering	30
4.2.6. Interconnection of conflicting IP networks	31
5. Comparison chart of classical and transparent proxies	31
6. Improving transparent proxies	32
7. Security Considerations	34

8. Acknowledgements	34
9. References	35

1. Background

An increasing number of organizations use IP security systems to provide specific access control when crossing network security perimeters. These systems are often deployed at the network boundary between two organizations (which may be part of the same "official" entity), or between an organization's network and a large public internetwork such as the Internet.

Some people believe that IP firewalls will become commodity products. Others believe that the introduction of IPv6 and of its improved security capabilities will gradually make firewalls look like stopgap solutions, and therefore irrelevant to the computer networking scene. In any case, it is currently important to examine the impact of inserting (and removing) a firewall at a network boundary, and to verify whether specific types of firewall technologies may have different effects on typical small and large IP networks.

Current firewall designs usually rely on packet filtering, proxy technology, or a combination of both. Packet filtering (although hard to configure correctly in a security sense) is now a well documented technology whose strengths and weaknesses are reasonably understood. Proxy technology, on the other hand, has been deployed a lot but studied little. Furthermore, many recent firewall products support a capability called "transparent proxying". This type of feature has been subject to much more marketing attention than actual technical analysis by the networking community.

It must be remembered that the Internet's growth and success is strongly related to its "open" nature. An Internet which would have been segmented from the start with firewalls, packet filters, and proxies may not have become what it is today. This type of discussion is, however, outside the scope of this document, which just attempts to provide an understandable description of what are network proxies, and of what are the differences, strengths, and weaknesses of "classical" and "transparent" network proxies. Within the context of this document, a "classical" proxy is the older (some would say old-fashioned) type of proxy of the two.

Also note that in this document, the word "connection" is used for an application session that uses TCP, while the word "session" refers to an application dialog that may use UDP or TCP.

2. Direct communication (without a proxy)

In the "normal" Internet world, systems do not use proxies and simply use normal TCP/IP to communicate with each other. It is important (for readers who may not be familiar with this) to take a quick look at the operations involved, in order to better understand what is the exact use of a proxy.

2.1 Direct connection example

Let's take a familiar network session and describe some details of its operation. We will look at what happens when a user on a client system "c.dmn1.com" sets up an FTP connection to the server system "s.dmn2.com". The client system's IP address is c1.c2.c3.c4, the server's IP address is s1.s2.s3.s4.

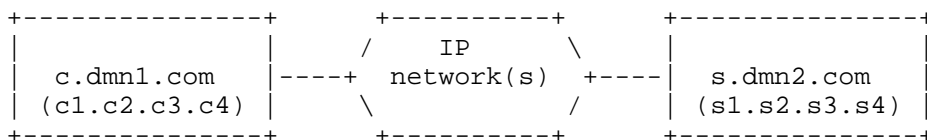

The user starts an instance of an FTP client program on the client system "c.dmn1.com", and specifies that the target system is "s.dmn2.com". On command-line systems, the user typically types:

```
ftp s.dmn2.com
```

The client system needs to convert the server's name to an IP address (if the user directly specified the server by address, this step is not needed).

Converting the server name to an IP address requires work to be performed which ranges between two extremes:

- a) the client system has this name in its hosts file, or has local DNS caching capability and successfully retrieves the name of the server system in its cache. No network activity is performed to convert the name to an IP address.
- b) the client system, in combination with DNS name servers, generate DNS queries that eventually propagate close to the root of the DNS tree and back down the server's DNS branch. Eventually, a DNS server which is authoritative for the server system's domain is queried and returns the IP address associated with "s.dmn2.com" (depending on the case, it may return this to the client system directly or to an

intermediate name server). Ultimately, the client system obtains a valid IP address for s.dmn2.com. For simplicity, we assume the server has only one IP address.

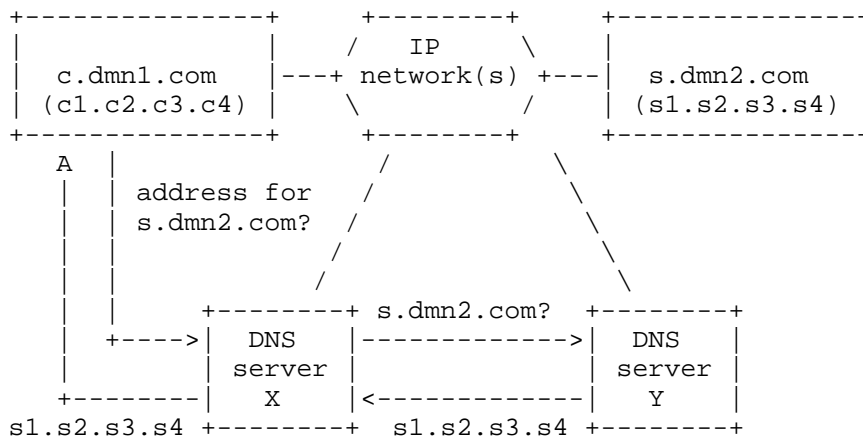

Once the client system knows the IP address of the server system, it attempts to establish a connection to the standard FTP "control" TCP port on the server (port 21). For this to work, the client system must have a valid route to the server's IP address, and the server system must have a valid route to the client's IP address. All intermediate devices that behave like IP gateways must have valid routes for both the client and the server. If these devices perform packet filtering, they must ALL allow the specific type of traffic required between C and S for this specific application.

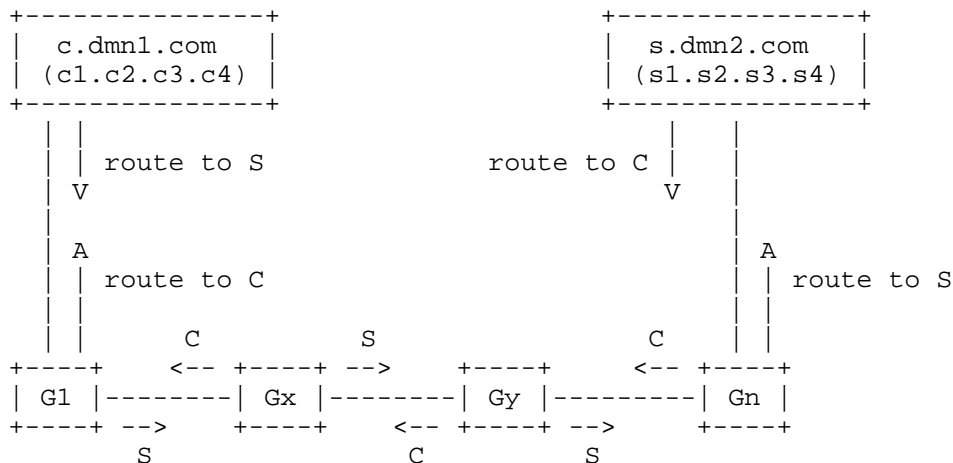

The actual application work for the FTP session between the client and server is done with a bidirectional flow of TCP packets between the client's and server's IP addresses.

The FTP protocol uses a slightly complex protocol and TCP connection model which is, luckily, not important to the present discussion. This allows slightly shortening this document...

2.2 Requirements of direct communication

Based on the preceding discussion, it is possible to say that the following is required for a direct session between a client and server to be successful:

- a) If the client uses the NAME of the server to reference it, the client must either have a hardcoded name-to-address binding for the server, or it must be able to resolve the server name (typically using DNS). In the case of DNS, this implies that the client and server must be part of the same DNS architecture or tree.
- b) The client and server must be part of the same internetwork: the client must have a valid IP route towards the server, the server must have a valid IP route towards the client, and all intermediate IP gateways must have valid routes towards the client and server ("IP gateway" is the RFC standard terminology; people often use the term "IP router" in computer rooms).
- c) If there are devices on the path between the client and server that perform packet filtering, all these devices must permit the forwarding of packets between the IP address of the client and the IP address of the server, at least for packets that fit the protocol model of the FTP application (TCP ports used, etc.).

3. Classical application proxies

A classical application proxy is a special program that knows one (or more) specific application protocols. Most application protocols are not symmetric; one end is considered to be a "client", one end is a "server".

A classical application proxy implements both the "client" and "server" parts of an application protocol. In practice, it only needs to implement enough of the client and server protocols to accomplish the following:

- a) accept client sessions and appear to them as a server;
- b) receive from a client the name or address of the final target server (this needs to be passed over the "client-proxy" session in a way that is application-specific);
- c) setup a session to the final server and appear to be a client from the server's point of view;
- d) relay requests, responses, and data between the client and server;
- e) perform access controls according to the proxy's design criteria (the main goal of the proxy, after all).

The functional goal of the proxy is to relay application data between clients and servers that may not have direct IP connectivity. The security goal of the proxy is to do checks and types of access controls that typical client and server software do not support or implement.

The following information will make it clear that classical proxies can offer many hidden benefits to the security-conscious network designer, at the cost of deploying client software with proxy capabilities or of educating the users on proxy use.

Client software issues are now easier to handle, given the increasing number of popular client applications (for Web, FTP, etc.) that offer proxy support. Designers developing new protocols are also more likely to plan proxy capability from the outset, to ensure their protocols can cross the many existing large corporate firewalls that are based at least in part on classical proxy technology.

3.1 Classical proxy session example

We will repeat our little analysis of an FTP session. This time, the FTP session is passing through a "classical" application proxy system. As is often the case (although not required), we will assume that the proxy system has two IP addresses, two network interfaces, and two DNS names.

The proxy system is running a special program which knows how to behave like an FTP client on one side, and like an FTP server on the other side. This program is what people call the "proxy". We will assume that the proxy program is listening to incoming requests on the standard FTP control port (21/tcp), although this is not always the case in practice.

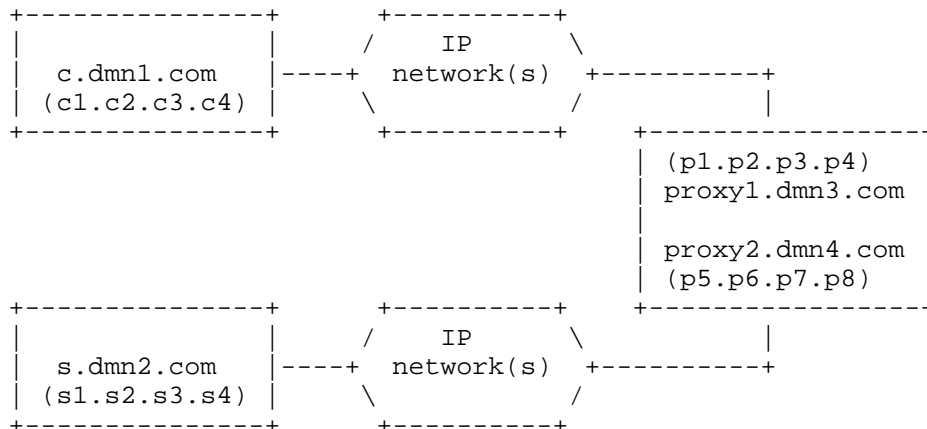

The user starts an instance of an FTP client program on the client system "c.dmn1.com", and MUST specify that the target system is "proxy1.dmn3.com". On command-line systems, the user typically types:

```
ftp proxy1.dmn3.com
```

The client system needs to convert the proxy's name to an IP address (if the user directly specified the proxy by address, this step is not needed).

Converting the proxy name to an IP address requires work to be performed which ranges between two extremes:

- a) the client system has this name in its hosts file, or has local DNS caching capability and successfully retrieves the name of the proxy system in its cache. No network activity is performed to convert the name to an IP address.
- b) the client system, in combination with DNS name servers, generate DNS queries that eventually propagate close to the root of the DNS tree and back down the proxy's DNS branch. Eventually, a DNS server which is authoritative for the proxy system's domain is queried and returns the IP address associated with "proxy1.dmn3.com" (depending on the case, it may return this to the client system directly or to an intermediate name server). Ultimately, the client system obtains a valid IP address for proxy1.dmn3.com.

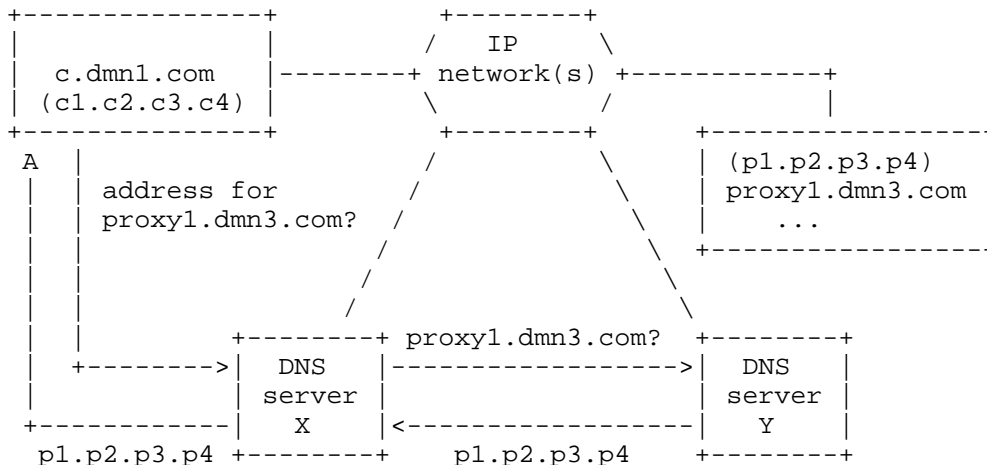

Once the client system knows the IP address of the proxy system, it attempts to establish a connection to the standard FTP "control" TCP port on the proxy (port 21). For this to work, the client system must have a valid route to the proxy's IP address, and the proxy system must have a valid route to the client's IP address. All intermediate devices that behave like IP gateways must have valid routes to both the client and the proxy. If these devices perform packet filtering, they must ALL allow the specific type of traffic required between C and P1 for this specific application (FTP).

Finally, the proxy system must accept this incoming connection, based on the client's IP address (the purpose of the proxy is generally to do access control, after all).

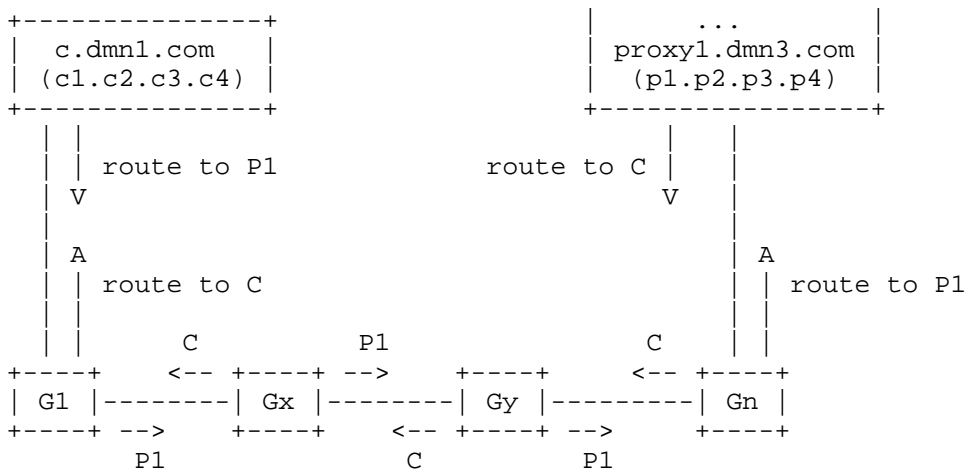

The actual application work for the FTP session between the client and proxy is done with a bidirectional flow of TCP packets between the client's and proxy's IP addresses.

For this to work, the proxy FTP application MUST fully support the FTP protocol and look identical to an FTP server from the client's point of view.

Once the client<->proxy session is established, the final target server name must be passed to the proxy, since, when using a "classical" application proxy, a way MUST be defined for the proxy to determine the final target system. This can be achieved in three ways:

- a) The client system supplies the name or address of the final target system to the proxy in a method that is compatible with the specific application protocol being used (in our example, FTP). This is generally considered to be the main problem with classical proxies, since for each application being proxied, a method must be defined for passing the name or address of the final target system. This method must be compatible with every variant of client application that implements the protocol (i.e. the target-passing method must fit within the MINIMUM functionalities required by the specific application protocol).

For the FTP protocol, the generally popular method for passing the final server name to the proxy is as follows:

When the proxy prompts the FTP client for a username, the client specifies a string of the form:

```
target_username@target_system_name
or
target_username@target_ip_address
```

The proxy will then know what is the final target system. The target_username (and the password supplied by the client) will be forwarded "as is" by the proxy to the final target system.

A well-known example of an FTP proxy that behaves in this way is the "ftp-gw" program which is part of the Trusted Information System's firewall toolkit, available by anonymous FTP at ftp.tis.com. Several commercial firewalls also support this de-facto standard.

- b) If there is only one possible final destination, the proxy may be configured to know this destination in advance. Since the IP address of the client system is known when the proxy must make this decision, the proxy can (if required) select a different destination based on the IP address of the client.
- c) The client software may also support capabilities that allow it to present to the user the illusion of a direct session (the user just specifies the final target system, and the client software automatically handles the problem of reaching to the proxy system and passing the name or address of the final target system in whatever mutually-acceptable form).

A well-known example of a system that provides modified client software, proxy software, and that provides the illusion of transparency is NEC's SOCKS system, available by anonymous FTP at ftp.nec.com.

Alternatively, several FTP client applications support the "username@destination_host" de-facto standard implemented (for example) by the "ftp-gw" proxy application.

Once the FTP proxy application knows the name or IP address of the target system, it can choose to do two things:

- a) Setup a session to the final target system, the more frequent case.
- b) Decide (based on some internal configuration data) that it cannot reach the final target system directly, but must go through another proxy. This is rare today, but may become temporarily common due to the current shortage of IP network numbers which encourages organizations to deploy "hidden" network numbers which are already assigned elsewhere. Sessions between systems which have the same IP network number but which belong to different actual networks may require going through two proxy systems. This is discussed in more detail in section 3.2.6, "Interconnection of conflicting IP networks".

If the FTP proxy decides to connect directly to the target system, and what it has is the target system name, it will need to convert the target system name into an IP address. If this process involves DNS resolution, something like the following will happen:

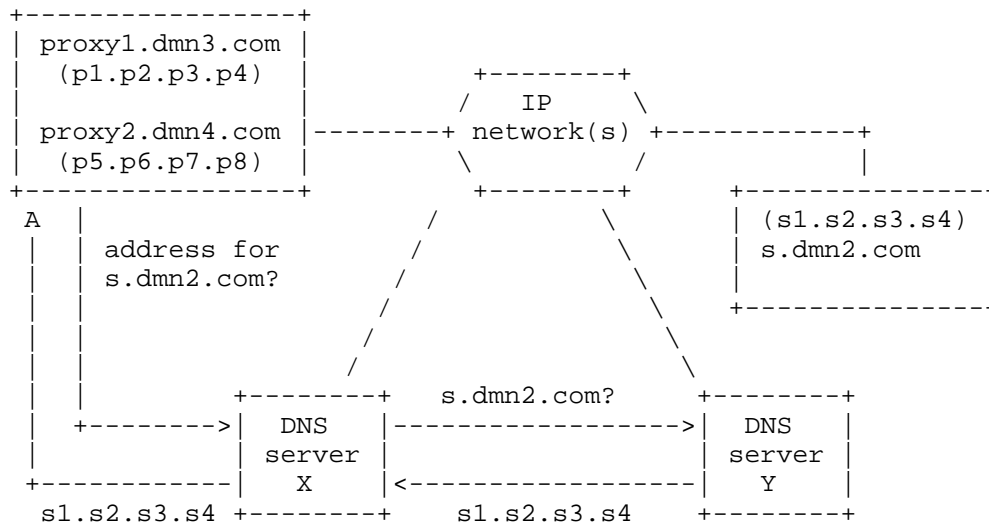

Once the proxy system knows the IP address of the server system, it attempts to establish a connection to the standard FTP "control" TCP port on the server (port 21). For this to work, the proxy system must have a valid route to the server's IP address, and the server system must have a valid route to at least one of the proxy's IP address. All intermediate devices that behave like IP gateways must have valid routes to both the proxy and the server. If these devices perform packet filtering, they must ALL allow the specific type of traffic required between the proxy and S for this specific application.

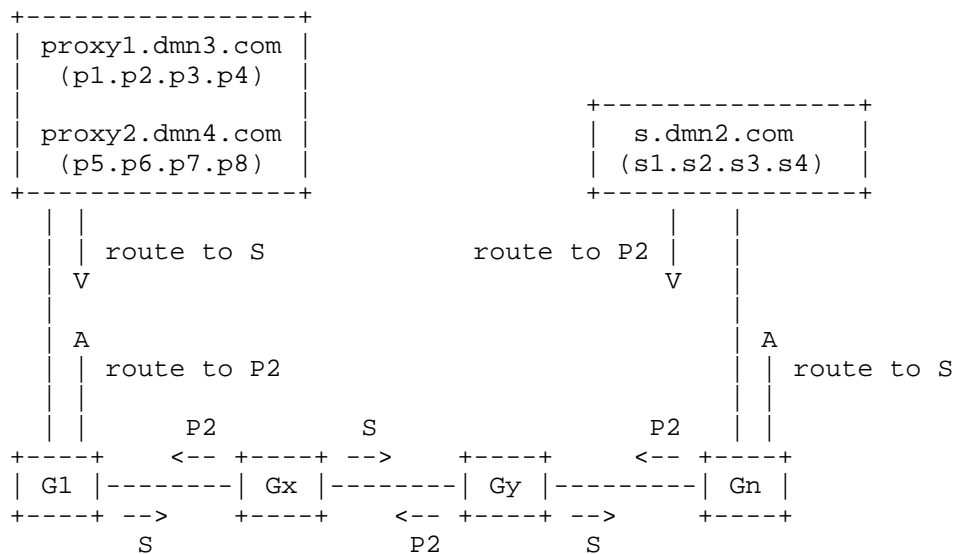

The actual FTP application work between the proxy and server is done with a bidirectional flow of TCP packets between the proxy's and server's IP addresses.

What actually happens BETWEEN THE CLIENT AND SERVER? They both send replies and responses to the proxy, which forwards data to the "other" end. When one party opens a data connection and sends a PORT command to the proxy, the proxy allocates its own data connection and sends its PORT command to the "other" end. The proxy also copies data across the connections created in this way.

3.2 Characteristics of classical proxy configurations

Several IP internetworks may be linked using only classical proxy technology. It is currently popular to link two specific IP internetworks in this way: the Internet and some organization's "private" IP network. Such a proxy-based link is often the key component of a firewall.

When this is done, several benefits and problems are introduced for network administrators and users.

3.2.1 IP addressing and routing requirements.

The proxy system must be able to address all client and server systems to which it may provide service. It must also know valid IP routes to all these client and server systems.

Client and server systems must be able to address the proxy system, and must know a valid IP route to the proxy system. If the proxy system has several IP addresses (and often, several physical network interfaces), the client and server systems need only to be able to access ONE of the proxy system's IP addresses.

Note that client and server systems that use the proxy for communication DO NOT NEED valid IP addressing or routing information for systems that they reach through the proxy.

In this sense, it can be said that systems separated by a classical proxy are isolated from each other in an IP addressing sense and in an IP routing sense.

On the other hand, the classical proxy system (if running a standard TCP/IP software stack) needs to have a single coherent view of IP addressing and routing. If such a proxy system interconnects two IP networks and two systems use the same IP network/subnetwork number (one system on each network), the proxy will only be able to address one of the systems.

This restriction can be removed by chaining classical proxies (this is described later in section 3.2.6, "Interconnection of conflicting IP networks").

Using a classical proxy for interconnection of IP internetworks, it is also possible, with care, to achieve a desirable "fail-safe" feature: no valid routing entries need to exist for an internetwork which should be reached only through the proxy (routing updates that could add such entries should be BLOCKED). If the proxy suddenly starts to behave like an IP router, only one-way attacks become possible.

In other words, assume an attacker has control of the remote internetwork and has found a way to cause the proxy to route IP packets, or has found a way to physically bypass the proxy.

The attacker may inject packets, but the attacked internal systems will be unable to reply to those packets. This certainly does not make attacks infeasible (as exemplified by certain holiday-period events in recent years), but it still makes attacks more difficult.

3.2.2 IP address hiding

Application "sessions" that go through a classical proxy are actually made of two complete sessions:

- a) a session between the client and the proxy
- b) a session between the proxy and the server

A device on the path sees only the client<->proxy traffic or the proxy<->server traffic, depending where it is located. If the two sessions actually pass through the same physical network, a device on that network may see both traffics, but may have difficulty establishing the relationship between the two sessions (depending on the specific application and activity level of the network).

A by-product of a classical proxy's behavior is commonly known as "address hiding". Equipments on some side of a classical proxy cannot easily determine what are the IP addresses used on another side of the proxy.

Address hiding is generally viewed as a Good Thing, since one of the purposes of deploying proxies is to disclose as little information about an internetwork as possible.

People who are in charge of gathering network statistics, and who do not have access to the proxy system's reports (if any) may consider address hiding to be a Bad Thing, since the proxy obscures the actual client/server relationships where the proxy was inserted. All IP activity originates and terminates on the proxy itself (or appears to do so).

In the same way, server software that accepts connections that have gone through a classical proxy do not see the IP address of the incoming client, unless this information is included in the application protocol (and even if it is, in many cases, the proxy will replace this information with its own address for the protocol to be consistent). This makes server access control unusable if it is based on client IP address checks.

3.2.3 DNS requirements

In most classical-proxy configurations, client systems pass the desired server name (or address) to the proxy system WITHOUT INTERPRETING IT. Because of this, the client system DOES NOT REQUIRE to be able to resolve the name of the server system in order to access it through a classical proxy. It only needs to be able to resolve the name of the proxy (if referencing the

proxy system by name).

Because of this, it can be said that a classical proxy system can offer DNS isolation. If two IP internetworks use completely separate DNS trees (each with their own DNS root servers), client software in one IP internetwork may still reference a server name in the other IP internetwork by passing its name to the classical proxy.

The classical proxy itself will not be able alone to resolve DNS names in both environments (if running standard DNS resolution software), since it will need to point to one or the other of the two DNS "universes".

A well-known technique called "split-brain DNS" can be used to relax this restriction somewhat, but such a technique ultimately involves prioritizing one DNS environment over another. If a DNS query can return a valid answer in both environments, only one of the answers will be found by the proxy.

3.2.4 Software requirements

A classical proxy application is a fairly simple piece of software, often simpler than either a real client implementation or a real server implementation. Such a program may run on any system that supports normal TCP/IP connections, and often does not require "system" or "superuser" privilege.

Classical proxy connections have no impact on normal server software; the proxy looks like a normal client in most respects except for its IP address and its "group" nature. All connections from the network on the other side of the proxy appear to come from the proxy, which poses problems if access control by client system is desired.

Normal client software may access a classical proxy if the user is willing or able to go through the extra steps necessary to indicate the final server to the proxy (whatever they are). Alternatively, modified (or newer) client software may be used that knows how to negotiate transparently with the proxy.

3.2.5 Impact of a classical proxy on packet filtering

If packet filtering is needed around a classical proxy, the packet filtering rules tend to be simplified, since the only traffic needed and allowed will originate from or terminate on the proxy (in an IP sense).

If the proxy starts behaving like an IP router, or if it is physically bypassed, such filtering rules, if deployed generally within an IP internetwork, will tend to prevent any direct traffic flow between the "internal" internetwork and "external" internetworks that are supposed to be only reachable through the application proxy.

3.2.6 Interconnection of conflicting IP networks

By chaining classical proxies, it is possible to achieve some interconnection of IP networks that have a high level of conflict. In practice, this type of setup resolves IP addressing conflicts much better than DNS conflicts. But DNS conflicts are currently less of a problem because the DNS "address space" is almost infinitely large (has anybody calculated the possible DNS address space based on the RFC-standard maximum host name length?).

Even though RFC 1597 was never more than an informational RFC, many organizations have been quietly following its suggestions, for lack of an easier solution. Now assume two organizations each use class A network number 10 on their network. Suddenly, they need to interconnect. What can they do?

First possibility: one side changes network number (not as hard as people think if properly planned, but this still represents some work)

Second possibility: they merge the two numbers by renumbering partially on each side to remove conflicts (actually harder to do, but has the political advantage that both sides have to do some work)

Third possibility: they communicate through chained classical proxies:

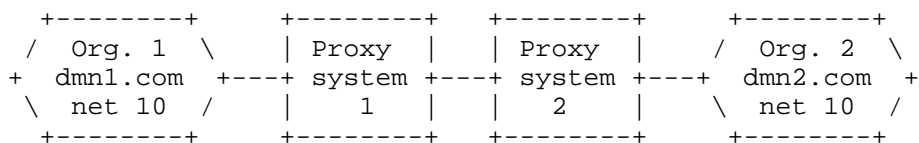

Both proxy 1 and 2 are standard systems running normal TCP/IP software stacks. Their configuration is not typical, however:

- a) The link between proxy 1 and proxy 2 may use any IP network number that is not used (or not needed) on either side. Nothing on Org.1 and Org.2's networks need to have an IP route to this network.
- b) Proxy 1 has an IP route for network 10 that points to Organization 1's network, and does DNS resolution (if required) using dmn1.com's name servers.
- c) Proxy 2 has an IP route for network 10 that points to Organization 2's network, and does DNS resolution (if required) using dmn2.com's name servers.
- d) Proxy 1 and proxy 2 only require a host IP route to each other for communication.
- e) For this to be convenient, the classical proxy applications must support the automatic selection of a destination based on the client IP address.
- f) On proxy system 1, the proxy software treats incoming sessions from proxy system 2 in the normal way: the "client" (proxy system 2) will be prompted in an application-specific way for the final destination. However, incoming sessions from Org.1 addresses are immediately and automatically forwarded to proxy system 2.

Proxy system 2 is configured similarly (that is, connections coming from proxy 1 are prompted for a target server name, connections from Org.2 addresses are immediately and automatically forwarded to proxy 1.

From a user's point of view, the behavior of such a chained proxy system is not very different from a single classical application proxy:

- a) A user on a client system with address 10.1.2.3 on Org.1's network wishes to do an anonymous FTP to "server.dmn2.com".
- b) The user starts an FTP towards proxy 1. Proxy 1 sees an incoming connection from an address in network 10, so it immediately relays the connection to proxy 2.
- c) Proxy 2 sees a connection coming from proxy 1, so it prompts the client. The user sees the username prompt

and types (assuming FTP proxies that behave like TIS's ftp-gw):

anonymous@server.dmn2.com

This will be resolved IN THE CONTEXT OF Org. 2'S NETWORK. The user can then complete the dialog and use the FTP connection.

- d) Note that this setup will work even if the client and server have the EXACT SAME IP ADDRESS (10.1.2.3 in our example).

If the proxy applications support selecting another proxy based on the destination supplied by the client, and if DNS domains are unique, more than two conflicting IP networks can be linked in this way! Here is an example configuration:

- a) Four IP networks that all use network 10 are linked by four proxy systems. The four proxy systems share a common, private IP network number and physical link (LAN or WAN).
- b) A user on organization 1's network wishes to access a server on network 3. The user connects to its local proxy (proxy 1) and supplies that target system name.
- c) Proxy 1 determines, based on a configuration rule, that the target system name is reachable by using proxy 3. So it connects to proxy 3 and passes the target system name.
- d) Proxy 3 determines that the target system name is local (to itself) and connects to it directly.

Security Implications of chained proxies

Obviously, when such "chained" configurations are built, access control rules and logging based on a final-client/final-server combination are difficult to enforce, since the first proxy in the chain sees a final-client/proxy relationship and the last proxy in the chain sees a proxy/final-server relationship.

Doing better than this requires that the proxies be capable of passing the "original-client" and

"final-destination" information back and forth in the proxy chain for access control and/or logging purposes. This requires the proxies to trust each other, and requires the network path to be trusted (forging this information becomes an excellent attack).

Even if these problems were to be solved reliably, the original goal of the proxy chains was to solve an IP and possibly a DNS conflict. The "original-client" and "final-destination" values may not have the same meaning everywhere in the overall setup. Tagging the information with a "universe-name" may help, assuming it is possible to define unique universe names in the first place. Obviously this topic requires more study.

4. Transparent application proxies

The most visible problem of classical application proxies is the need for proxy-capable client programs and/or user education so that users know how to use the proxies.

When somebody thought of modifying proxies in such a way that normal user procedures and normal client applications would still be able to take advantage of the proxies, the transparent proxy was born.

A transparent application proxy is often described as a system that appears like a packet filter to clients, and like a classical proxy to servers. Apart from this important concept, transparent and classical proxies can do similar access control checks and can offer an equivalent level of security/robustness/performance, at least as far as the proxy itself is concerned.

The following information will make it clear that small organizations that wish to use proxy technology for protection, that wish to rely entirely on one proxy system for network perimeter security, that want a minimal (or zero) impact on user procedures, and that do not wish to bother with proxy-capable clients will tend to prefer transparent proxy technology.

Organizations with one or more of the following characteristics may prefer deploying classical proxy technology:

- a) own a substantial internal IP router network, and wish to avoid adding "external" routes on the network
- b) wish to deploy "defence in depth", such as internal firewalls, packet filtering on the internal network
- c) wish to keep their DNS environment fully isolated from the "other side" of their proxy system, or that fear that their

- d) use some IP networks that are in conflict with the "other side" of their proxy system
- e) wish to use proxy applications that are easily portable to different operating system types and/or versions
- f) wish to deploy multiple proxy systems interconnecting them to the SAME remote network without introducing dynamic routing for external routes on the internal network

4.1 Transparent proxy connection example

Let us go through an FTP session again, through a "transparent" proxy this time. We assume that the proxy system has two IP addresses, two network interfaces, and two DNS names.

The proxy system is running a special program which knows how to behave like an FTP client on one side, and like an FTP server on the other side. This program is what people call the "proxy". This program, being a transparent proxy, also has a very special relationship with the TCP/IP implementation of the proxy system. This relationship may be built in several ways, we will describe only one such possible way.

We will assume that the proxy program is listening to incoming requests on the standard FTP control port (21/tcp), although this is not always the case in practice.

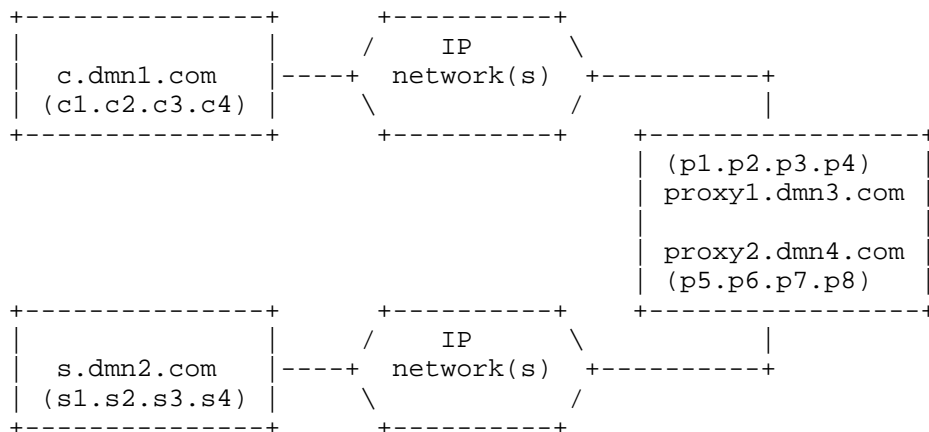

The user starts an instance of an FTP client program on the client system "c.dmn1.com", and specifies a destination of "s.dmn2.com", just like if it was reachable directly. On command-line systems, the user typically types:

```
ftp s.dmn2.com
```

The client system needs to convert the server's name to an IP address (if the user directly specified the server by address, this step is not needed).

Converting the server name to an IP address requires work to be performed which ranges between two extremes:

- a) the client system has this name in its hosts file, or has local DNS caching capability and successfully retrieves the name of the proxy system in its cache. No network activity is performed to convert the name to an IP address.
- b) the client system, in combination with DNS name servers, generate DNS queries that eventually propagate close to the root of the DNS tree and back down the server's DNS branch. Eventually, a DNS server which is authoritative for the server system's domain is queried and returns the IP address associated with "s.dmn2.com" (depending on the case, it may return this to the client system directly or to an intermediate name server). Ultimately, the client system obtains a valid IP address for s.dmn2.com.

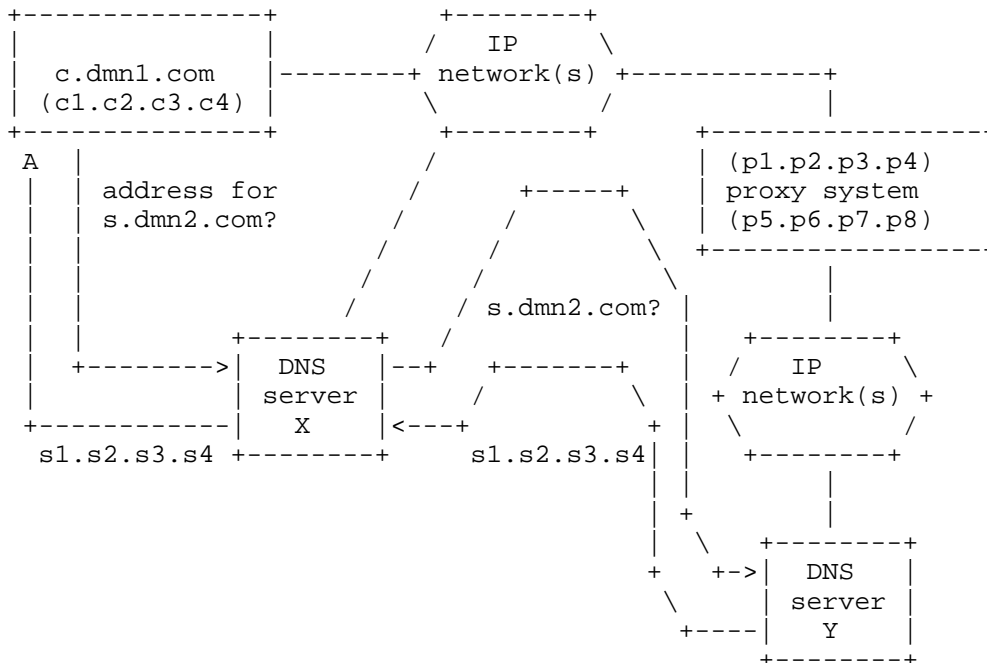

NOTE: In practice, DNS servers that are authoritative for s.dmn2.com are highly likely to be located on the OTHER side of the proxy system. This means that DNS queries from the inside to the outside MUST be able to cross the proxy system. If the proxy system wishes to provide "address hiding", it must make these DNS queries (originating from the inside) appear to come from the proxy itself. This can be achieved by using a BIND-based DNS server (which has some proxy capabilities) or some simpler DNS proxy program. For full RFC compliance, the proxy system must be able to relay TCP-based queries just like UDP-based queries, since some client systems are rumored to ONLY use TCP for DNS queries.

The proxy system must be able to detect and block several classes of attacks based on DNS which (if nothing else) may cause denial of service:

- a) attempts from the outside to return corrupt cache entries to an internal DNS server
- b) attempts to return DNS bindings which have no relationship to the actual DNS query (some DNS servers are vulnerable to this). The attacker's goal may be to prime the cache of internal DNS servers with

- interesting entries, including entries for internal DNS names that point to external IP addresses...
- c) data-driven stuff similar in style to the "syslog buffer overrun" type attacks.

Once the client system knows the IP address of the server system, it attempts to establish a connection to the standard FTP "control" TCP port on the server (port 21). For this to work, the client system must have a valid route for the server's IP address THAT LEADS TO THE PROXY SYSTEM, and the proxy system must have a valid route for the client's IP address and the server's IP address. All intermediate devices that behave like IP gateways must have valid routes for the client, the server, and usually the proxy. If these devices perform packet filtering, they must ALL allow the specific type of traffic required between C and S for this specific application.

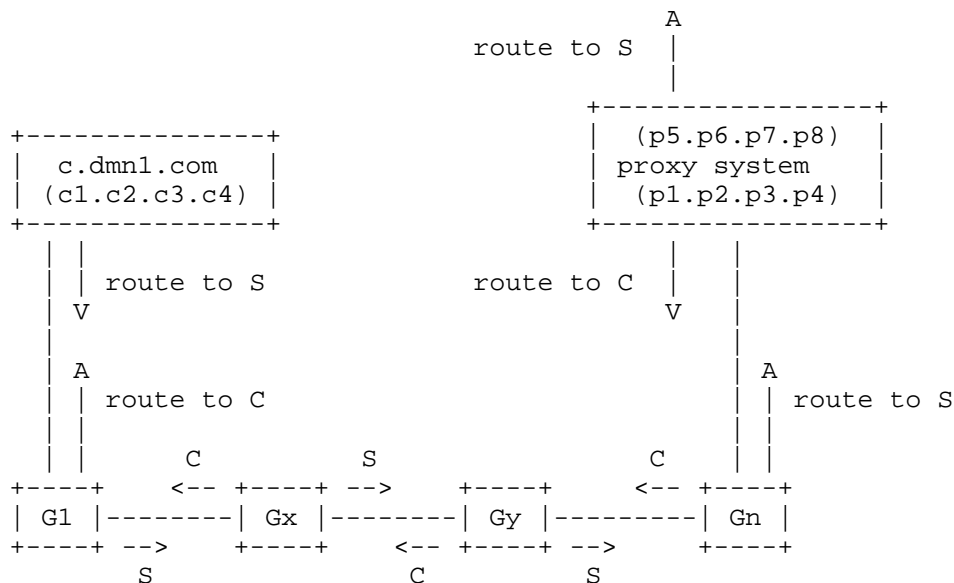

At the start of the FTP session, a TCP packet with a source address of C and a destination address of S travels to the proxy system, expecting to cross it just like a normal IP gateway.

This is when the transparent proxy shows its magic:

The proxy's TCP/IP software stack sees this incoming packets (and subsequent ones) for a destination address that is NOT one of its own addresses. Based on some criteria (a configuration file, for

example), it decides NOT to forward or drop the packet (which are the only two choices an RFC-standard TCP/IP implementation would have). The proxy system accepts the packet as if it was directed to one of its own IP addresses.

In our example, the incoming packet is a TCP packet. Since standard TCP/IP stacks store both a LOCAL and REMOTE IP address field for each TCP connection, the transparent proxy may set the LOCAL IP address field to the IP address that the client wants to reach (s1.s2.s3.s4 in our example). The standard TCP/IP stack probably needs to be modified to do this. UDP examples, although not connection-based, could be handled in similar ways.

Once this is done, the actual FTP proxy application is invoked since an incoming connection to TCP port 21 has occurred. It can determine what is the final target destination instantly, since the LOCAL IP address field of the connection contains the target server's IP address. There is no need for the proxy application to ask the client what is the final target system.

Since the FTP proxy application knows the IP address of the target system, it can choose to do two things:

- a) Setup a session to the final target system, the more frequent case.
- b) Decide (based on some internal configuration data) that it cannot reach the final target system directly, but must go through a "classical" proxy. This seems technically feasible, although no real transparent proxy system is known to offer this capability. The actual value of such a feature (if available) would need to be studied.

If the FTP proxy decides to connect directly to the target system, it has the target system's IP address. It may choose to do a reverse lookup on the target IP address to obtain a target system name (possibly needed for access control). If this process involves DNS resolution, something like the following will happen:

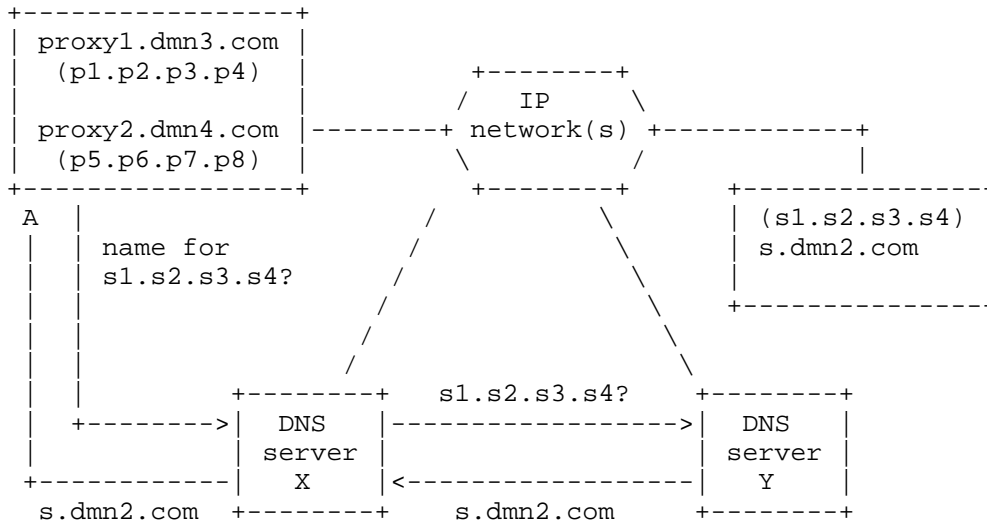

Once this is done and if the connection is allowed, the proxy attempts to establish a connection to the standard FTP "control" TCP port on the target server (port 21), using a technique identical to a "classical" proxy. For this to work, the proxy system must have a valid route to the server's IP address, and the server system must have a valid route to at least one of the proxy's IP address. All intermediate devices that behave like IP gateways must have valid routes to both the proxy and the server. If these devices perform packet filtering, they must ALL allow the specific type of traffic required between the proxy and S for this specific application.

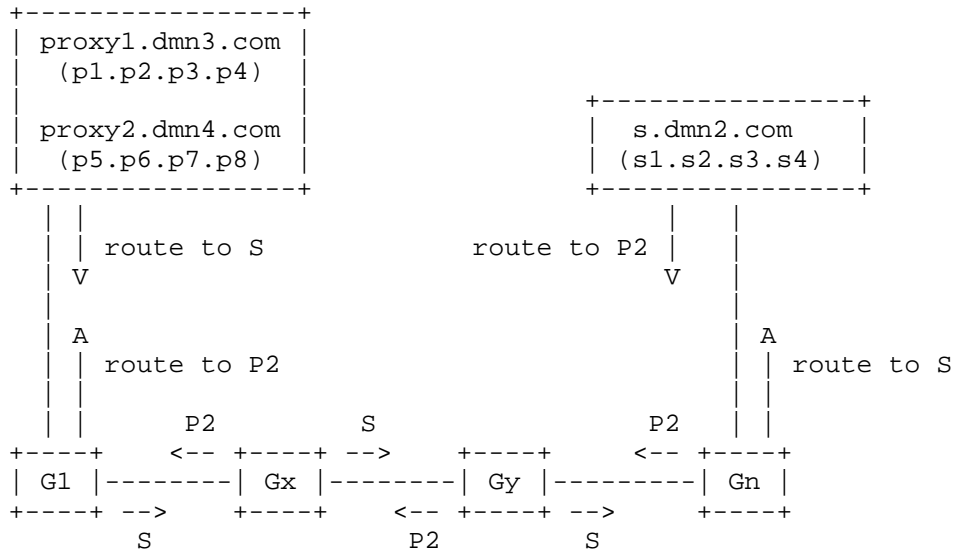

The rest of the transparent proxy's operation is very similar to what would happen with a classical proxy.

4.2 Characteristics of transparent proxy configurations

Transparent proxy technology can be used to build the key component of a "firewall", in a way quite similar to the way classical proxy technology may be used. Several important details of the architecture must be different, however.

4.2.1 IP addressing and routing requirements

The transparent proxy system must be able to address all client and server systems to which it may provide service. It must also know valid IP routes to all these client and server systems.

Server systems must be able to address the proxy system, and must know a valid IP route to the proxy system. If the proxy system has several IP addresses (and often, several physical network interfaces), the server systems need only to be able to access ONE of the proxy system's IP addresses.

Client systems MUST HAVE valid IP addressing and routing information for systems that they reach through the proxy. For example, in the common case where a transparent proxy is being used to interconnect a private network and the Internet, the

private network will effectively need to use a default route that points to the transparent proxy system. This is a specific need of transparent proxy configurations.

Interconnecting two internetworks with multiple transparent proxies (for load sharing or fail-over) can be accomplished by using different techniques from what would be done for classical proxies:

- a) with multiple classical proxies to the same remote network, clients can be configured to access different proxies manually, or DNS-based techniques, such as DNS load-balancing may be used to make clients access a different proxy at different times.
- b) with multiple transparent proxies to the same remote network, the internal network must be able to provide dynamic routing towards the proxies (routing updates may need to be supplied by the proxies themselves). Client systems (depending on topology) may not need to see the route changes, but internal backbone routers probably do.

It is clear that internetworks linked by a transparent proxy cannot be fully isolated from each other in an IP addressing and routing sense. The network on which client systems are located must have effective valid routing entries to the remote internetwork; these routing entries must point to the proxy.

The transparent proxy system (if running a vaguely standard TCP/IP software stack) needs to have a single coherent view of IP addressing and routing. If a proxy system interconnects two IP networks and two systems use the same IP network/subnetwork number (one system on each internetwork), the proxy will only be able to address one of the systems. Even if the proxy is able to manage multiple conflicting IP universes (if, for example, one instance of a complete TCP/IP stack and its data structures is bound to each of the proxy network interfaces), the client systems will still have a problem: Why should it send packets with this network number to the proxy since this network number exists also on the internal internetwork?

Chaining transparent proxies does not seem at first glance to solve IP conflicts like it does for classical proxies.

From a "security" fail-safe point of view, the transparent proxy has an undesirable characteristic: the network being protected must have valid routing entries to the remote

network(s). If the proxy fails (starts behaving like a non-filtering IP router) or is physically bypassed, it is likely that the internal network will be immediately able to reply to "attacker" packets. The attacker does not need to modify routing tables or to spoof internal IP addresses.

This is important for organizations that do not wish to place ALL their confidence and protection into a proxy system (for whatever reason).

4.2.2 IP address hiding

Application "sessions" that go through a transparent proxy are actually made of two complete sessions:

- a) a session between the client and the address of the server, the session being "intercepted" by the proxy
- b) a session between the proxy and the server

A device on the path sees either the client<->server traffic or the proxy<->server traffic, depending where it is located. The client<-server traffic is actually generated by the transparent proxy. The two sessions SHOULD NEVER pass through the same physical network, since in that case (due to the routing requirements) a total bypass of the proxy at the IP routing level may easily occur without being detectable.

Like classical proxies, transparent proxies accomplish a form of IP address hiding. Client IP addresses are hidden from the servers, since the servers see a session being initiated by the proxy. Server IP addresses are NOT hidden from the clients however, so that the illusion of transparency may be maintained.

This difference implies that internal (client-side) network statistics at the IP level will accurately reflect what outside destinations are being accessed. This can be useful for analyzing traffic patterns.

4.2.3 DNS requirements

In transparent proxy configurations, client systems MUST be able to resolve server names belonging to remote networks. This is critical since the proxy will determine the target server from the destination IP address of the packets arriving from the client. Because of this, the "client" internetwork needs to have some form of DNS interconnection to the remote network. If internal client and name server IP addresses must be hidden

from the outside, these DNS queries must also be proxied.

Of course, remote host name/address relationships may be stored locally on the client systems, but it is well known that such an approach does not scale...

Because of this, it can be said that a transparent proxy system cannot offer DNS isolation. If two IP internetworks use completely separate DNS trees (each with their own DNS root servers), client software in one IP internetwork will not have a way of finding name/address relationships in the "other" DNS tree, and this information must be obtained in order to pass the desired address to the transparent proxy.

The classical proxy itself (if running standard DNS resolution software) will not be able alone to resolve DNS names in both environments, since it will need to point to one or the other of the two DNS "universes". Running multiple instances of DNS resolution software can allow the proxy to do this, however.

Because of the requirement placed on some form of DNS communication through the proxy, it is critical for the proxy to be able to protect ITSELF, internal clients, and internal name servers from data-driven attacks at the DNS level.

4.2.4 Software requirements

The big advantage of transparent proxies is that normal client software may access remote servers with no modifications and no changes to user procedures.

The transparent proxy application itself may not need to be more complicated than a classical proxy application.

However, the proxy TCP/IP software stack cannot be a fully-standard (well, today's standard at least) TCP/IP stack, and requires specific extensions:

- a) the ability to specify ranges of IP addresses that do not belong to the proxy itself, but for which "intercept" processing will occur: if packets arrive at the proxy with a destination IP address in those ranges, the IP stack will not forward or drop the packets; it will pass them up to application layers.
- b) This mechanism requires that applications may obtain both the IP address from which the packets come, and the address to which the packets were going. Typical

IP stacks should already have the fields available to store the info; it is a matter of updating them properly for these "intercepted" packets.

- c) In the case of "intercepted" TCP packets, the TCP stack must support establishing TCP connections where the "local" IP address is not one of the proxy's IP address.

Any TCP/IP software implementation should be modifiable to perform these tasks. If a standard API becomes widely available to drive these extensions, and if this API is generally implemented, transparent proxies may become "portable" applications.

Until this occurs, it must be assumed that implementors have chosen different ways of accomplishing these functions, so that today's transparent proxy applications cannot be fully portable. It also remains to be seen how much work is needed to propagate these "extensions" to IPV6 software stacks.

4.2.5 Impact of a transparent proxy on packet filtering

The nature of a transparent proxy's functionality makes it difficult to deploy good packet filtering on the "inside" (or client-side) of the proxy. The proxy will "masquerade" as all the external systems. Because of this, internal packet filters WILL TYPICALLY NEED TO ALLOW IP traffic between internal and external IP addresses.

Depending on the actual security policy of the network, it may be possible to do filtering based on protocol type and/or on TCP bits (to filter based on connection setup direction), but filtering that blocks external IP addresses CANNOT be deployed.

If the proxy starts behaving like an IP router, or if physically bypassed, the practical limitations imposed on internal packet filtering imply that a lot of direct traffic between the inside and outside network will be allowed to flow. Furthermore, as we have seen previously, the internal network will have valid routing entries for external network numbers that point to the proxy. If multiple proxies have been deployed, the internal network may even HAVE TO TRUST routing updates generated by the proxy.

In general, if an internal network wishes to communicate with an external network through a transparent proxy, it MUST BE FUNDAMENTALLY DESIGNED TO COMMUNICATE DIRECTLY with that

external network. This is true at the IP addressing level, at the IP routing level, and at the DNS level. A proxy security failure in this type of environment is likely to result in immediate, total, and undetected accessibility of the internal network by the external network.

4.2.6 Interconnection of conflicting IP networks

Unlike classical proxies, transparent proxies do not readily seem useful in solving IP addressing conflicts.

If two internetworks use the same network number(s), systems and routers in each internetwork will have valid routes to these network numbers. If these routes are changed to point to a transparent proxy, traffic that is meant to stay within the same internetwork would start to flow towards the proxy. The proxy will not be able to distinguish reliably between traffic between systems of the same internetwork, and traffic which is meant to cross the proxy.

A possible solution to this problem is described in section 6 of this document, "Improving transparent proxies".

5. Comparison chart of classical and transparent proxies

For those who do not like longish discussions of technical details, here is a one-page summary of the strengths/weaknesses/differences of classical and transparent proxies:

Issue	Classical Proxy	Transparent Proxy
IP addressing	systems/gateways on each network need to address the proxy	systems/gateways on the "client" network need to address the remote networks
IP routing	systems/gateways on each network need a valid routing entry for the proxy	systems/gateways on the "client" network also need routing entries for remote entries
IP address hiding	systems on each side of the proxy are hidden from each other	systems on the "client" side are hidden from the other sides

DNS	full isolation possible	resolution of outside names by inside systems is required
Proxy software requirements	runs on standard TCP/IP stack; can be portable	requires special TCP/IP stack; not 100% portable
Client software requirements	requires proxy-capable software or user education	nothing more than for a direct connection
User requirements	must use proxy-capable software or know how to use the proxy	nothing more than for a direct connection
Packet filtering	can filter out "external" addresses	cannot filter out "external" addresses
IP address conflict resolution	can be done with chained proxies that support auto-connect	no obvious way to get this to work

6. Improving transparent proxies

The main issues with transparent proxies seem to revolve around the need to force "client" systems to directly access external addresses. To some people, this characteristic makes a transparent proxy look too much like a complicated packet filter. Can this problem be solved?

The first possibility that comes to mind is to use the flexibility of the DNS protocol to build new tricks. If we restrict the "internal" clients so that they MUST ALWAYS use DNS to resolve external host names AND THAT THEY MUST NEVER store permanent copies of external host addresses, the following technique would become theoretically possible (this is a very painful restriction, by the way):

- a) arrange for all internal queries for external DNS names to go to the transparent proxy system (this can be done in a number of ways).
- b) arrange for a routing entry to exist for a class A network number that is not used on the internal network. This IMPLIES that the internal network may not be part of the Internet. This routing entry will point to the transparent proxy system. For

the purpose of our discussion, this special network number will be X.0.0.0.

- c) when an internal system generates a query for an external address, the query (if no answer is cached on the internal network) will reach the proxy system. Assuming the query is to obtain the IP address corresponding to a domain name, the proxy will go through the following algorithm:

- try to find a valid binding for this external domain name in its local cache
- if not found, it will ITSELF launch an external DNS query for the domain name. When (and if) it receives a valid reply, it creates a local cache entry containing:

- Time To Live of the reply
 - Expiry Time of the cache entry (based on the current time)
 - External domain name
 - External IP address
 - Dynamically allocated IP address of the form X.x1.x2.x3.

and returns to the client the dynamically allocated IP address in the range X.0.0.0, NOT THE REAL ONE.

- the client may (or may not) store the IP address returned in its cache, and will then attempt to connect to the dynamically allocated IP address. This traffic will arrive at the proxy because of the routing setup.
- The transparent proxy intercepts the traffic and can identify the actual desired target it should connect to based on the dynamically allocated IP address supplied by the client.

Such an approach, if workable, could improve many characteristics of transparent proxies and may even make transparent proxies capable of handling IP network number conflicts.

However, the algorithm above leaves many difficult questions unsolved. Here is a list (by no means exhaustive) of these questions:

- a) What is the percentage of client DNS resolver and DNS server implementations that conform to the RFC specifications in their handling of the Time-To-Live field?
- b) How should the proxy handle other types of DNS queries for external domain names (inverse queries, queries for other resource record types)?

- c) A client program may perform a DNS query once for an external name and then use the response for a long time (a large file transfer, or a permanent management session, for example). Should the proxy update the Expiry Time of cache entries based on the passing IP traffic, and if so, using what algorithm?
- d) What new types of attacks would such a system introduce or make possible?
- e) What data structures and resources (memory, disk) would be needed for an efficient implementation if the proxy must sustain a high rate of DNS queries for external names, and where a large number of different external names are referenced? The class A network number is used basically to reference cache entries. Would a 24-bit address space be sufficient for practical use?
- f) What happens with the cache (and the functionality) if the proxy crashes or reboots?

Such a system would probably exhibit two types of intermittent failures:

- a) a client system is still using the result of an external name query (some X.x1.x2.x3 address dynamically allocated by the proxy), but this binding no longer exists in the proxy's cache. The client attempts a connection to this address, which fails.
- b) a client's name cache contains a binding for X.x1.x2.x3, but the proxy has already reused this address for a different external host name. The client attempts a connection to this address, sees no obvious errors, but reaches a different system from the expected one.

If somebody has ever implemented such a scheme, information and live experience in deploying it would be useful to the IP networking community.

7. Security Considerations

Most of this document is concerned with security implications of classical and transparent proxy technology.

8. Acknowledgements

I could not have written this document without the support of Digital Equipment Corporation for whom I work as a consultant.

9. References

- [1] Cheswick, W., Bellovin, S., "Firewalls and Internet Security: Repelling the Wily Hacker", Addison-Wesley, 1994.
- [2] Chapman, B., Zwicky, E., "Building Internet Firewalls", O'Reilly and Associates, Inc., September 1995.
- [3] Comer, D., "Internetworking with TCP/IP volume 1: Principles, Protocols, and Architecture", Prentice-Hall, 1991.
- [4] Comer, D., Stevens, D., "Internetworking with TCP/IP volume 2: Design, Implementation, and Internals", Prentice-Hall, 1991.
- [5] Postel, J., and J. Reynolds, "File Transfer Protocol (FTP)", STD 9, RFC 959, USC/Information Sciences Institute, October 1985.
- [6] Huitema, C., "An experiment in DNS Based IP Routing", RFC 1383, INRIA, December 1992.
- [7] Rekhter Y., Moskowitz B., Karrenberg D., de Groot, G., "Address Allocation for Private Internets", RFC 1597, IBM Corp., Chrysler Corp, RIPE NCC, March 1994.
- [8] The TIS firewall toolkit's documentation, available on Trusted Information System's anonymous FTP site, ftp.tis.com.
- [9] Many discussions in the last 18 months on the firewalls-digest mailing list maintained by Great Circle Associates. The archives of the list are maintained at ftp.greatcircle.com.

Author's Address

Marc Chatel
9, avenue Jean Monnet
74940 ANNECY-LE-VIEUX
FRANCE

EMail: mchatel@pax.eunet.ch
or at Digital Equipment:
Marc.Chatel@aeo.mts.dec.com